

## 94110 Vacuum Vent

The Shand & Jurs 94110 Vacuum Vent has been designed utilizing over 90 years experience in the development of quality safety and conservation fittings. The function of this vent is to relieve vacuum conditions in liquid product storage tanks, and also withstand the pressure of the stored product when not operating under a vacuum.

Vacuum breathing requirements of some petroleum products may vary so much from pressure breathing, that it is sometimes desirable and more economical to have separate vents to perform these respective functions.

A minimum number of model options are required to cover the wide variety of fluids and temperatures encountered in the petroleum, chemical and general process industries. Many trims, body materials and settings are standard options for those few conditions where standard construction is unsuited.

Standard materials of construction include low copper aluminum, steel, stainless steel or cast iron body. Metal seats are provided to withstand high pressures to which the vent may be subjected.

The body is self-draining and drip rings keep condensates from the seating surfaces. The Teflon diaphragm of the pallet has high resistance to adhesion by ice and gum formation, thus preventing sticking to the seat ring.

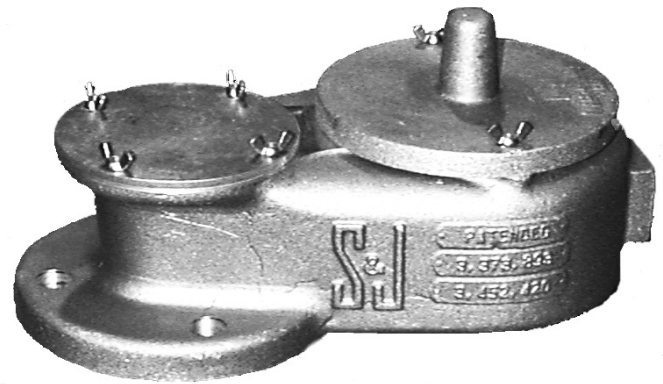

## Features

- Less need for special materials in corrosive and extreme temperature
- Unique floating diaphragm construction assures tight seal
- Peripheral and stem guided vacuum pallet assures reliable operation
- Vertical Lift Pallet contributes to high flow capacity
- Heavy duty construction, yet compact enough for easy handling

## Materials of Construction:

Service	Body	Vacuum Cover	Seat		Pallets	Stem Guides	Screen
			2, 3, 4	6, 8, 10 & 12			
Normal Alum	Cast Alum.	Aluminum	Aluminum	Aluminum	Aluminum	Galv. Steel	Galv. Steel
Severe Iron	Cast Iron	Carbon Steel	316 SS	316 SS	316 SS	Galv. Steel	304 SS
Severe Steel	Cast Steel	Carbon Steel	* 316 SS	* 316 SS	316 SS	Galv. Steel	304 SS
Severe 316 SS	Cast 316 SS	316 SS	316 SS	316 SS	316 SS	316 SS	316 SS

\* SS Overlay on Integral Seat

Service	Pallet Stem	Diaphragm	Spacer	Cover O-Ring	Size Guides	Hardware
Normal Alum	**Alum.	FEP	N-8090	Buna-N	316 SS	Stainless Steel
Severe Iron	316 SS	FEP	N-8090	Buna-N	316 SS	316 SS
Severe Steel	316 SS	FEP	N-8090	Buna-N	316 SS	Stainless Steel
Severe 316 SS	316 SS	FEP	N-8090	Buna-N	316 SS	316 SS

\*\* 316 SS for elevated settings > 2.9 oz/in<sup>2</sup>

N-8090 = Nitrile Fiber Composition Non-asbestos. FEP = Teflon

Materials of construction in this equipment have been selected as representing the most suitable commercially available material for use in the service intended. However, they do not constitute a guarantee against corrosion since processes vary from plant to plant and concentration of harmful fluids, gasses or solids vary from time to time in a given process. Empirical experience by users should be the final guide and alternate materials based on this are generally available.

### Standard Max Pressure (PSIG)

Size	Alum. Pallet	S.S. Pallet
2"	15	17.5
3"	15	8
4"	8.5	4
6"	4.0	2.25
8"	2.3	1.25
10"	1.4	1.2
12"	1.2	1.2

### \*Max Std Vacuum Setting (oz/sq<sup>2</sup>)

Size	Lead Weights	S.S. Weights
2"	7.5 oz.	6.0 oz.
3"	9 oz.	7.5 oz.
4"	10.5 oz.	7.5 oz.
6"	12 oz.	7.5 oz.
8"	13.5 oz.	9 oz.
10"	16.5 oz.	12 oz.
12"	21 oz.	15 oz.

\*Higher settings maybe available. Consult Factory.

### Principle of Operation:

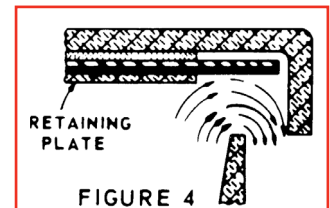
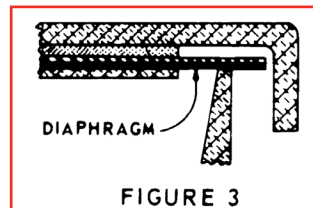
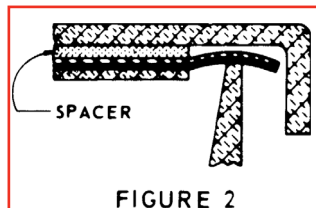
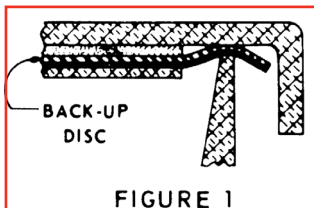

Figure 1 shows the relation of the vacuum pallet assembly to the seat when atmospheric and tank pressures are equal. The "wrap around" effect of the resilient diaphragm on the edge of the seat and the resulting high ratio of seating force to seating area affords a tight seal.

As the vacuum increases, the pallet begins to rise as shown in Figure 2. Because there is still a wrap

around effect on the edge of the seat, good sealing is maintained. Teflon diaphragm memory and lapped seating surface further enhance sealing characteristics.

As increasing vacuum continues to lift the pallet (see Figure 3) the diaphragm is held in close proximity to

## Principle of Operation Continued:

the seat by the flat plane memory of the diaphragm material.

As set vacuum is reached, the diaphragm leaves the seat (see Figure 4) and the in-rushing vapor lifts the pallet even further.

The vacuum pallet lifts vertically permitting incoming air to enter the valve body. This relieves the vacuum condition.

In the closing cycle, incoming air on the pallet holds the Teflon diaphragm close to the pallet surface until peripheral seat contact is very near 100%, causing closure to occur at a value very close to the setting value.

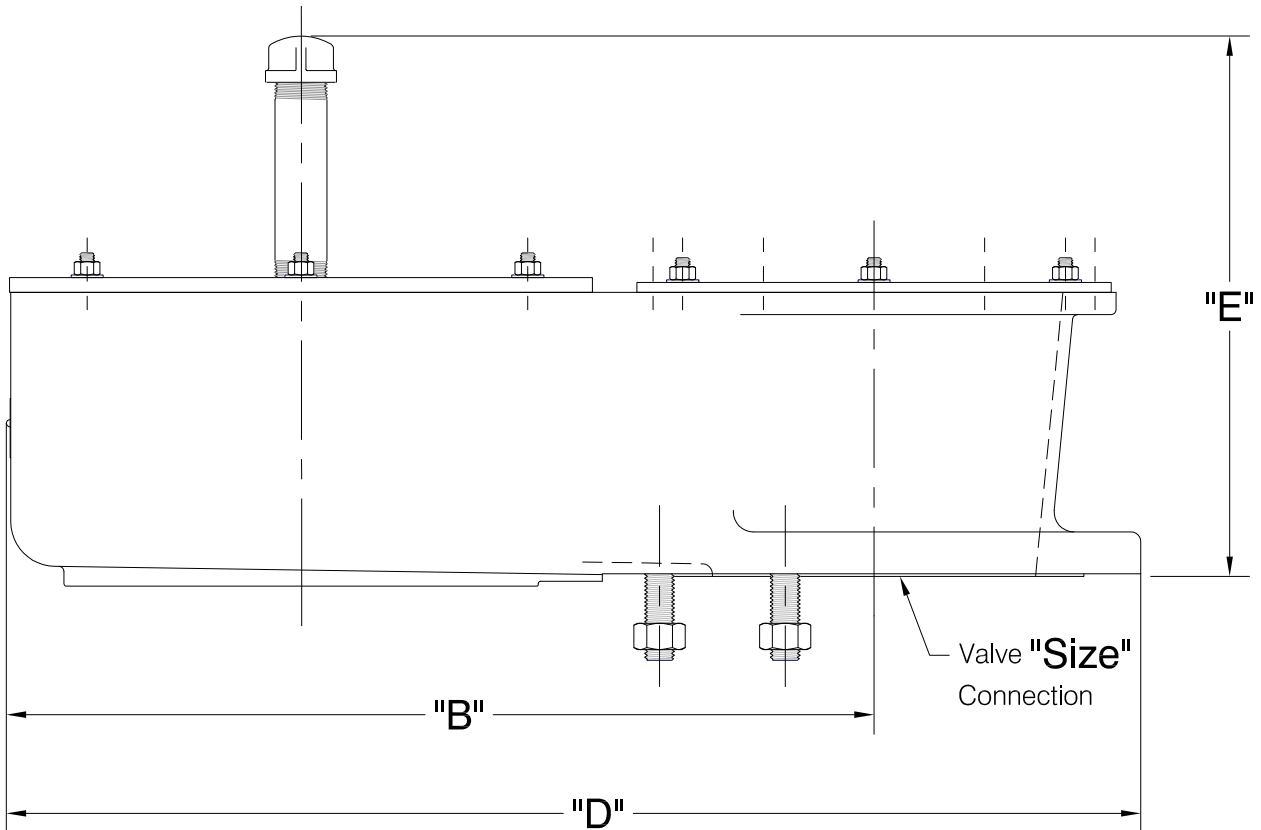

### NOTES:

1. Connection size matches 125 lb. FF/150 lb. RF ANSI FLANGE.
2. Mounting holes straddle centerline except: 2" & 3" sizes, holes are on centerline.
3. Dimensions expressed in inches.

Vent Size	"B"	"D"	"E"
2"	8 ¾	11 25/32	5 ¼
3"	11	14 15/16	6 ¼
4"	13 ¾	17 7/8	7 ¼
6"	17 7/8	23 7/16	10 ½
8"	22 1/8	28 19/32	12 ¾
10"	26 ½	34 ¼	16
12"	31 1/8	40 1/16	17

All designs subject to change. Certified dimensions and specifications available upon request.

## 94110 Ordering Guide

### Model Number Selection

The model number will consist of a base number **94110** followed by 8 digit numbers. These digits will represent 7 option tables.

**94110 - AB - CD - EF - GH**

### Ordering Information

Specify:

1. Model 94110 Vacuum Vent
2. Size and Body Material
3. Screwed or Flanged Connection on 2" and 3" Size
4. Vacuum Setting, if Other Than Normal
5. Optional Materials of Construction, as Required
6. Maximum Static Pressure
7. To Specify CE for Ordinary EU Locations use Table H2
8. To Specify ATEX Certification for Group IIB, IIA EU Locations use 94110A AB CD EF GH. ATEX Certification includes CE Mark.

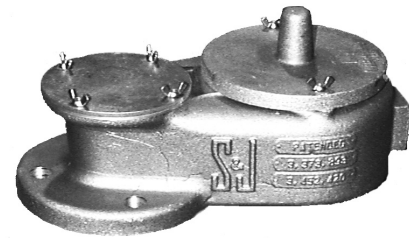

### Table AB - Size and Body

Option AB	Size	Connection	Body Material
11	2"	Threaded	Aluminum
12	2"	Flanged	Aluminum
13	3"	Threaded	Aluminum
14	3"	Flanged	Aluminum
15	4"	Flanged	Aluminum
16	6"	Flanged	Aluminum
17	8"	Flanged	Aluminum
18	10"	Flanged	Aluminum
19	12"	Flanged	Aluminum
31, 41	2"	Threaded	Cast Iron, Ductile Iron
32, 42	2"	Flanged	Cast Iron, Ductile Iron
33, 43	3"	Threaded	Cast Iron, Ductile Iron
34, 44	3"	Flanged	Cast Iron, Ductile Iron
35, 45	4"	Flanged	Cast Iron, Ductile Iron
36, 46	6"	Flanged	Cast Iron, Ductile Iron
37, 47	8"	Flanged	Cast Iron, Ductile Iron
38, 48	10"	Flanged	Cast Iron, Ductile Iron
39, 49	12"	Flanged	Cast Iron, Ductile Iron

Option AB	Size	Connection	Body Material
51	2"	Threaded	Cast Steel
52	2"	Flanged	Cast Steel
53	3"	Threaded	Cast Steel
54	3"	Flanged	Cast Steel
55	4"	Flanged	Cast Steel
56	6"	Flanged	Cast Steel
57	8"	Flanged	Cast Steel
58	10"	Flanged	Cast Steel
59	12"	Flanged	Cast Steel
61	2"	Threaded	316 Stainless Steel
62	2"	Flanged	316 Stainless Steel
63	3"	Threaded	316 Stainless Steel
64	3"	Flanged	316 Stainless Steel
65	4"	Flanged	316 Stainless Steel
66	6"	Flanged	316 Stainless Steel
67	8"	Flanged	316 Stainless Steel
68	10"	Flanged	316 Stainless Steel
69	12"	Flanged	316 Stainless Steel

### Table C - Flange Type

Option C	Description
0	ANSI 125/150lb. FF
1	ANSI 125/150lb. RF*
2	EN1092 PN16 FF
3	EN1092 PN16 RF*
4	JIS 10K FF
5	JIS 10K RF*

\* RF not available in Aluminum

### Table D - Vacuum Range & Load Weight Material

Option D	Description	Weights
0	Standard Setting 0.5 oz/in <sup>2</sup>	Lead
1	Above Standard to 2.9 oz/in <sup>2</sup>	Lead
2	Above 2.9 oz/in <sup>2</sup>	Lead
3	Standard Setting 0.5 oz/in <sup>2</sup>	316 SS
4	Above Standard to 2.9 oz/in <sup>2</sup>	316 SS
5	Above 2.9 oz/in <sup>2</sup>	316 SS

#### STD Vacuum Setting:

0.5 oz/in<sup>2</sup>

(2" Stainless Steel Pallets 0.608 oz/in<sup>2</sup>)

### Table E - Seat & Pallet Material

Option E	Seat	Pallet
0	Standard*	Standard*
1	Teflon Coated SS	Standard*
2	Aluminum	Standard*
4	Stainless Steel	Standard*
+ 5	Teflon	Standard*
A	Standard*	316 Stainless Steel
B	Teflon Coated SS	316 Stainless Steel
C	Aluminum	316 Stainless Steel
E	Stainless Steel	316 Stainless Steel
+ F	Teflon	316 Stainless Steel

+ These Options not Available with ATEX Models

### Table F - Cleaning

Option F	Cleaning
0	Normal
1	LOX
2	LIN

### Table G - Soft Goods

Option G	Description
0	Standard FEP/N8090
1	FEP (All)
2	VITON (All)
3	PTFE/KN9007 (Hi Temp)

### Table H - Trim

Option H	Description
0	Standard Trim*
1	Stainless Steel Trim**

\* See Materials of Construction

\*\* Includes stem, stem guides, side guides, nuts, bolts and screen  
For ATEX Certified Models, select Option 1.